

Re-imagining Mission in Light of COVID-19: An Extended Report

November 15, 2020

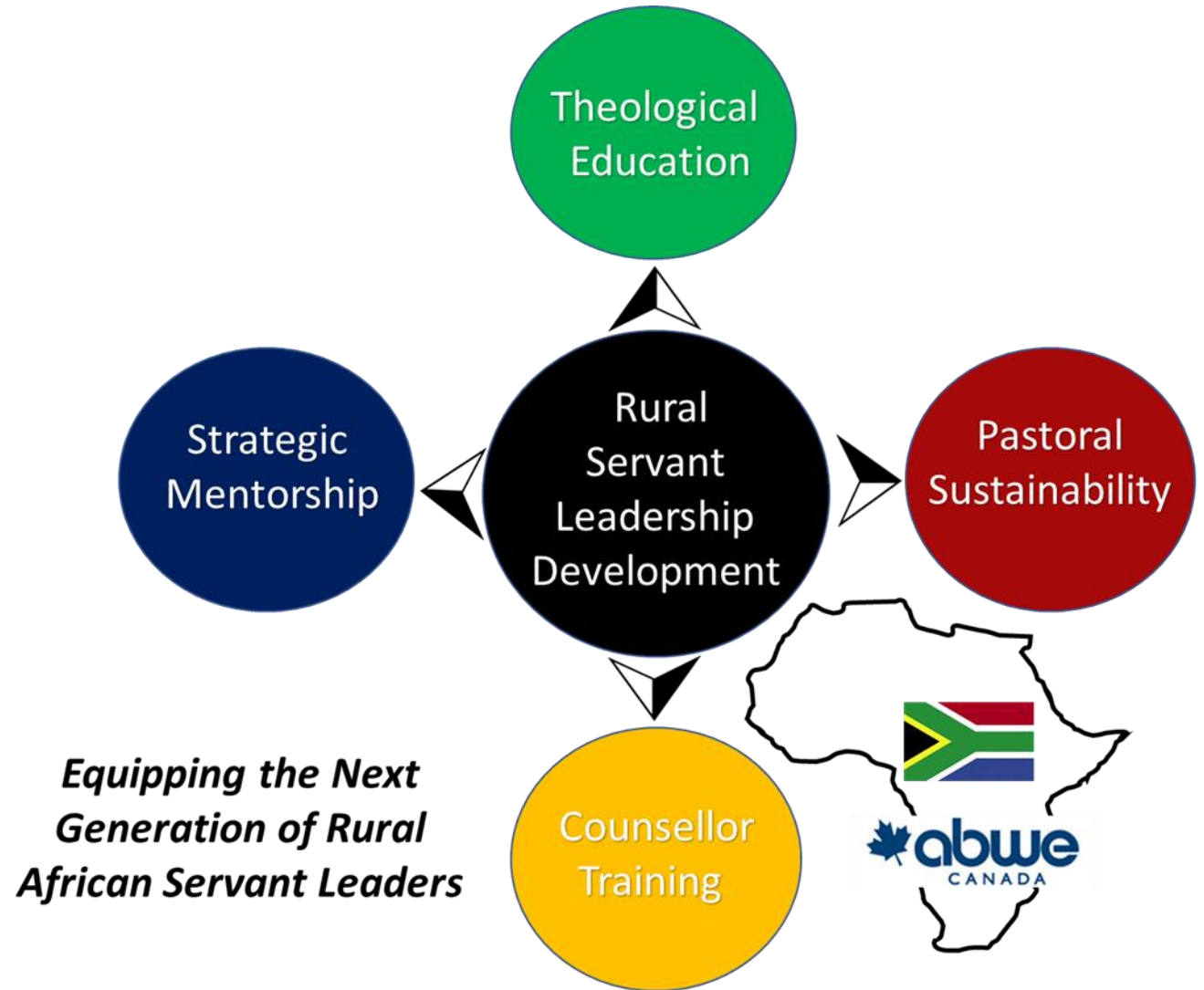

- COVID-19 forced us to rethink our strategy for mission.
- Mission is NOT about Craig and Rene Brannan but God working through Craig and Rene Brannan in the ***most effective strategies whereby God fulfills His purposes*** to equip the Next Generation of Rural African Servant Leaders.
- This is being fulfilled through
 - Theological Education
 - Pastoral Sustainability
 - Counsellor Training
 - Strategic Mentorship



All these ministries are explained on

YouTube Channel

“The Whole Counsel of God”

and

Cornerstone Baptist Church’s Website. See under **Missions –South Africa**

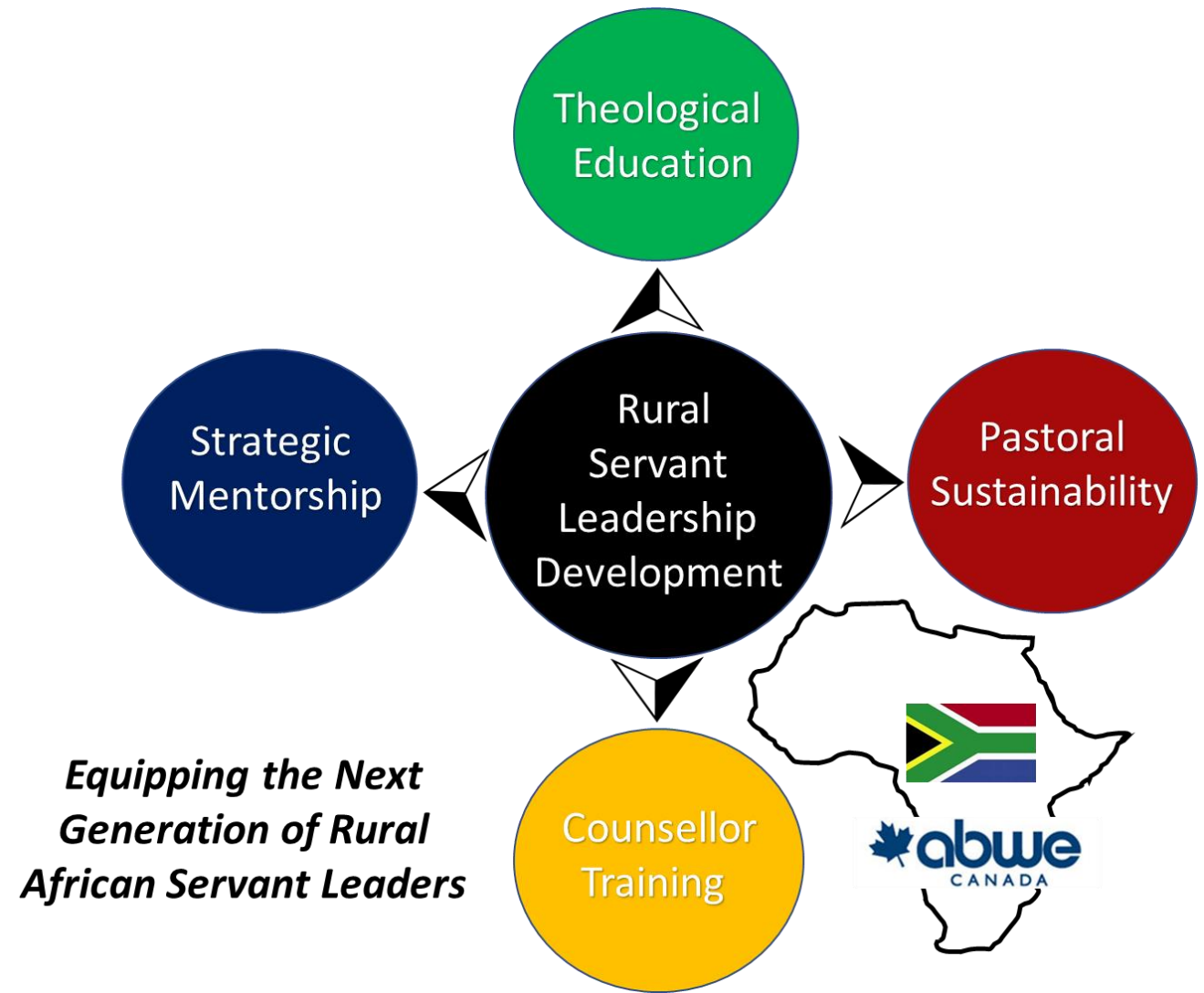

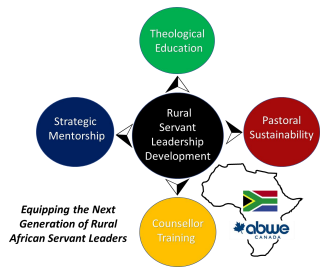

- Report from Pastor Shadrack Khumalo



- **“Theological Education** The global pandemic has also provided an opportunity for Pastor Shadrack to **build new relationships with pastors in rural areas**. Through those relationships he had an opportunity **to promote theological education in three new churches**. As a result, Mukhanyo Theological College has registered four new students. They will be doing higher certificate in theology at Empangeni Baptist Church. We received enough applications for next year. We will wait for our third-year students to complete their diploma in theology before we take more students. This **year’s total number of students has reached full capacity; 23 students**. Comprised of; **10 first year students, and 13 second year students**. ***This is a wonderful opportunity of ensuring that this and next generation receives solid Biblical teachings in rural and urban churches in South Africa***. Praise be to our God!!!

Pastor Shadrack's report: "The Zululand School of the Bible curriculum is uniquely tailored to not only provide Biblical knowledge but also to changed hearts – hearts that will seek after God, make Him known, and rightly proclaim the Word of God. Our students testify that God has used these 36 courses to challenge and change their lives, equipping them to be better stewards of the ministries that God has entrusted to them.

We praise God for the Partnership with Mukhanyo Theological College and **Cornerstone Baptist in Canada**. Through the support received from our partners in Canada we managed to **maintain the costs low which enable our students to afford study with us**. Through our partnership with Mukhanyo Theological College, Zululand School of the Bible is now able to offer an accredited diploma in Theology as of October 2017. Empangeni Baptist church invites students to apply for a three and half years diploma in Theology."



**Zululand School of the Bible
Graduation**

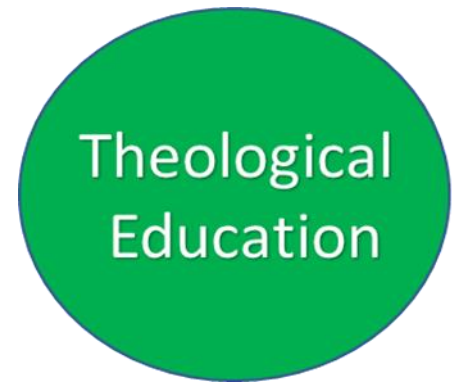

Graduates

**Certificate in Pastoral Ministry
(three years - thirty-six subjects)**

- Mr Protas Thembinkosi Dlamini
- Mr Zephania Lembede
- Mr Bongani Msane
- Mrs Silindile Patience Zungu
- Mr Wilson Shezi
- Mr Nkosingiphile Zulu

30 OCTOBER 2020

EMPANGENI BAPTIST

IN

**PARTNERSHIP WITH MUKHANYO THEOLOGICAL COLLEGE &
CORNERSTONE BAPTIST**



HIGHLIGHTS

Theological Education

- Empangeni Baptist Church people in their lack and some poverty have given to these Theological training
- LORD has graciously provided funds through Cornerstone Baptist church
- Working on Curriculum development for Zululand School of the Bible
- Working on recruitment of a potential Theological Educator

Praise Items

- We thank God for providing funds to support pastors during Covid-19 crisis.
- We thank God for providing funds for purchasing of vehicle to run ABWE ministry in rural areas.
- We thank God for providing food for starving families in rural areas and in our church.
- We thank God for smooth running of Mukhanyo Theological Education lecture in September amidst Covid-19 challenges.
- We thank God for providing for Pastor Wilson, Pastor Bongani and Pastor Vincent during lockdown.

Theological
Education



Prayer Items

- Pray for church administration workshop preparation
- Pray for Zululand School of the Bible lectures scheduled for last week of October 2020
- Pray for 2.5 million people who lost their employment because of the global pandemic of Covid-19
- Pray the victims of gender-based violence in South Africa.
- Pray for pastors, missionaries and their families that God will continue to provide for them and strengthen them.



Theological
Education



Pastoral Benevolence: A Support Ministry of

Pastoral
Sustainability

- COVID-19 has been devastating for many Rural pastors
- Pastoral Benevolence fund to assist Rural Pastors and their families with basic needs
- Pastor Shadrack Khumalo is the Benevolence Facilitator. He is travelling into the deep rural areas to visit, encourage and bring supplies to these Pastors.



Pastoral Benevolence Report from Pastor Shadrack – Pastoral Benevolence Facilitator



“One important lesson I have learned this year is that God’s plans prevails over our plans. As the church, we had specific plans for the year, but God’s Word proved to be true at all times, in Proverbs 16:9 says, “The heart of man plans his way, but the LORD establishes his steps.”

“While Covid-19 had taken the world by surprised, but it didn’t surprise our God. He had many good plans in place, which led us to stopping our plans and joining God in His plans. We rejoice in the fact that our God is Sovereign and that His purposes are more important than ours. We delight in serving God through new opportunities presented to us by the pandemic. Yes - Covid-19 has robbed over 2.5 million South Africans of their jobs and thousands of families are without income. “

Pastoral Benevolence Report from Pastor Shadrack – Pastoral Benevolence Facilitator



The church is also affected by the negative effects of the Covid-19 epidemic as many pastors are currently not receiving salaries. But our God is a provider, and it is our desire that you will rejoice with us in praising God for His faithfulness.

Funds were received from our ministry partners in Canada.

Those funds enable Empangeni Baptist Church to help pastoral families with some money to buy groceries for their families.

Local shops and Empangeni Baptist Church donated food to feed over 60 families in rural areas of Nkandla, Esikhawini and Mevamhlophe Area.



Pastoral Benevolence Report from Pastor Shadrack – Pastoral Benevolence Facilitator

Funds receive from our partners helped to cover travel costs to deliver much needed food parcels to starving families in rural areas.

We work with local pastors to distribute food to starving families, simple because local pastors are in a better position to know the families that need support most in their arears. At Nkandla, we work with three pastors, who are: Pastor Vincent Zulu, Pastor Shozi and Pastor Mboniseni Buthelezi. In Esikhawin we work with Ms Hellen Nkosi who is working as a youth worker with Scripture Union South Africa, Pastor Wilson Shezi and we also worked with Protas Dlamini.

Pastoral Benevolence: A Support Ministry of

Pastoral
Sustainability



Pastor Vincent Zulu with Pastor Shadrack Khumalo who delivers food parcels and funding



Pastoral Benevolence as a support ministry of Pastoral Sustainability



Pastor Shadrack Khumalo's report on Pastor Vincent

Pastor Vincent is on fire on evangelism, he is passionate to reach his community with the gospel. He requested help with church administration and discipleship program to help new converts to develop in their relationship with God. Pastor Shadrack has visited him five times to support him with church administration. But during those visits with Pastor Vincent a great need was identified to help other pastors with church administration in the area of Nkandla. Therefore, Pastor Shadrack has put together a church administration workshop for pastors in Nkandla area. Pastor Shadrack will work with Pastor Vincent and Pastor Shozi from Nkandla to organize a workshop for the pastors.

Pastoral
Sustainability



NKANDLA CHRISTIAN FELLOWSHIP CENTRE (NCFC) VUMANHLAVU AREA

TEL: 0648461445 P.O BOX 350 CELL: 0794713230 NKANDLA
svzulu01@gmail.com 3855 SMS: 0794713230 Ps SV&Z ZULU

WHATSAPP: 0794713230

THE LIFE CHANGING CHURCH

To whom it may concern

**Letter of
thanks
From
Pastor
Vincent**

I Pastor Siphamandla Vincent (Cwele) Zulu (ID No. 8503025598082) from KwaZulu Natal at Nkandla rural area, with my family, we had our second visit and received help from Pastor Shadrack Khumalo of Empangeni Baptist Church on the 9th of June 2020 - Tuesday afternoon. We received mouthful of goods, such as a full sack of women's clothing, a full sack Linen fabric, 40 Covid 19 Face musk, 20 for adults & 20 for children, Loads of Food parcels to share with the needy brethren and a cash amount of a thousand rand(R1000), which helped us a lot more especially with our labourer who is building our temporary structure we live in.

We are sincerely grateful with the support we received. May God bless you all brethren in the Lord and may He repay you back multiplied in Jesus mighty name. (Galatians 6:9-10).

Thank you very much.

Yours in the Lord.

Pastor S.V Zulu



The ministry of providing food to the Church and in the community has drawn people from the community. There are 30 attending Pastor Vincent's Church. He is wanting to develop discipleship material with Dr. Craig



Pastor Vincent's temporal church structure which has been a blessing to him. He is no longer using a tent which was to be erected every Sunday morning

The second essential focus of ministry in equipping the Next Generation of African Rural Leaders is ***developing disciplined church plants that intentionally initiate Pastoral Sustainability***

Pastoral Sustainability

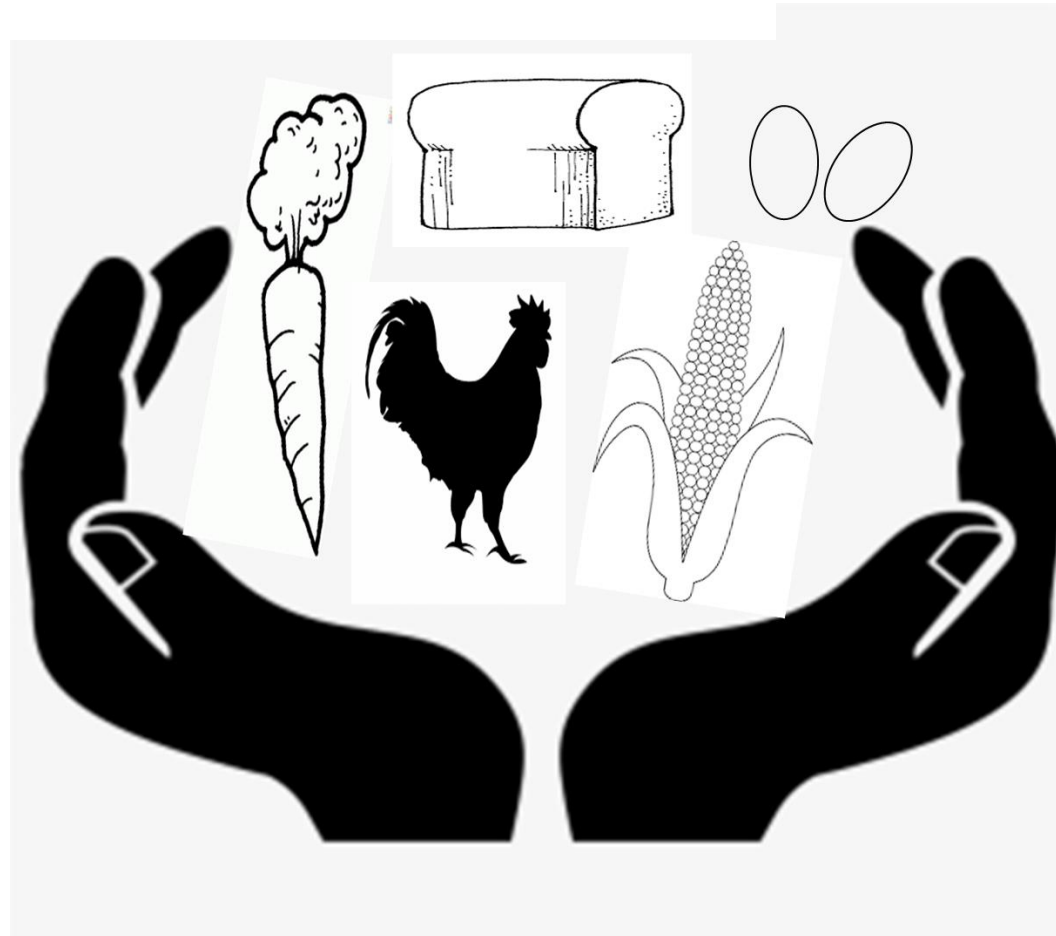

Equipping the Next Generation of Rural African Servant Leaders

Pastor Shadrack's report

“Pastor Wilson Shezi is doing well and we praise God for his provision for him and his family. IOP has been able to continue paying his salary during lockdown. He has bought 40 new chicken layers in order to continue producing eggs. The first 90 chicken layers that were donated to him start his business were no longer able to produce eggs. Wilson is selling his eggs in the shop which was built by a business man from Zimbabwe on his property, who is also paying rent to Pastor Wilson for running a shop in his property. ***In terms of pastoral sustainability projects, Pastor Wilson can be considered a success story.*** Pastor Wilson has gained good experience in running the egg production business. Other pastors are consulting him for help, as they also contemplate on starting egg production businesses. We praise God that Pastor Wilson's chicken project has proven to be one of the key projects in terms of sustainability projects. Pastors need more chicken layers to increase production and he will be in a good position to generate enough income to support his family”

Pastoral
Sustainability

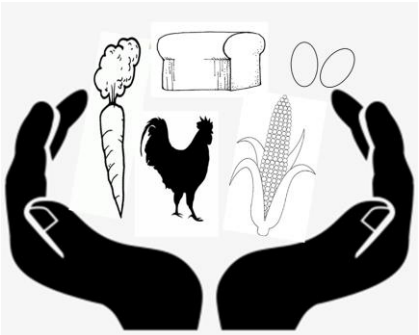

Pastoral
Sustainability

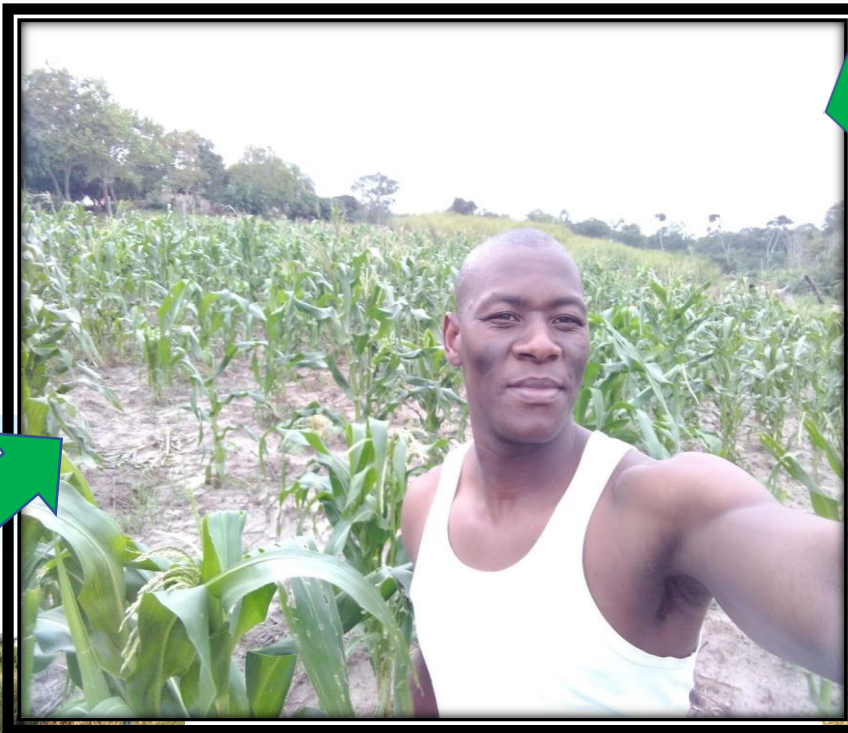

Pastor Bongani
Modeling and
Teaching Students
how to ***Farm God's
Way*** - using Plastic
Garbage Bags



Pastor Bongani
Building the Chicken
House-Breeding
Broilers. He has
made a successful
business from this



Pastoral
Sustainability



Pastoral
Sustainability

Pastor Bongani Msane

Pig Farming



Dukuduku Pig Farm



Contact details:0714662648/0835234786

Email address:Bonganimsane30@gmail.com

Pastoral
Sustainability

Well
Drilled
For Water.
They need
a pump so
they can
draw the
water for
the church



The real reason for Pastoral Sustainability

WhatsApp Voice message conversation with Pastor Bongani



- “I cannot stop what God has started. This work, the pigs, the chickens, the crops are all of God.
- “I am trying to give to the people “How to walk with God”. I am using the example of Abraham of how he walked with God. I am going this in the Church. I am also working through the Books of Acts.
- “Walking with God does not mean everything is going to run smooth. We trust God. We must walk with God. So, if you can send me Discipleship Material on how to walk with God. Thank you”



Pastoral
Sustainability



Pastor Bongani built this
with his hands





Bongani has started
a local business
“Zikhali Zabasane”



*To fight poverty for
the Next Generation*



The trajectory of Biblical Counsellor training addresses two pressing challenges:

Counsellor Training

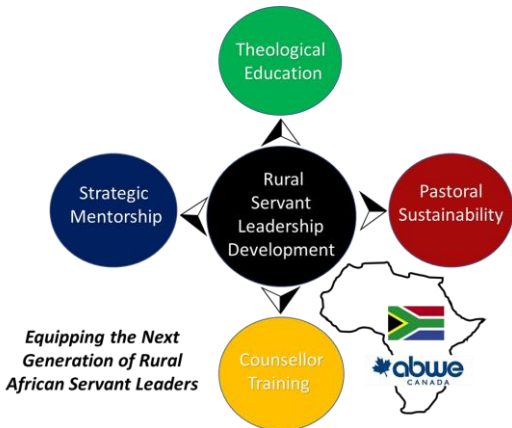

Equipping the Next Generation of Rural African Servant Leaders

The trajectory of Biblical Counsellor training address two pressing challenges:



Firstly, address the immediate and long term hurt, trauma and shame that Orphaned and Vulnerable Children to Young Adults have endured.



Equipping the Next Generation of Rural African Servant Leaders



The trajectory of Biblical Counsellor training address two pressing challenges:



Secondly, address the need to Biblically present and remind Orphaned and Vulnerable Children to Young Adults of ***their unique Redemptive Roles*** that are available to them **because of and under God's New Covenant** accomplished through the ***completed work of Christ on their behalf through His Sufficient Death, Burial and Resurrection***



Purpose:

Biblical Counsellor Training will instruct OVC to Young Adults with ***Biblical and practical Tools*** that will realign hurting OVC and Young Adults to a ***restored, redeemed and repaired relationship*** with a **New Father**. This will encourage them to embrace **Whose they are as Adopted Children by and with** their New Father. Therefore, this redefines **Who they are and assists them to reinterpret their pain and suffering** as He works in and through them by His Word and Spirit.

Counsellor
Training



Currently researching and working on Work Books and lessons on

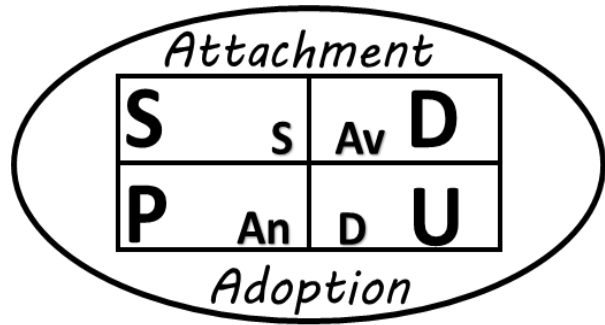

Adopted into a New Family with a New Father -
Ephesians 1:1-14, Galatians 4: 1-7, Romans 8:11-17

Developing an In-Depth Understanding of Adult Attachment Styles with focus on their Secure Attachment with God through Jesus Christ.



Currently researching and working on Work Books and lessons on



Understanding the effects of Internalized Shame - The Core Effects of Shame (Genesis 3)



Navigating the Complexity of Trauma and Triggers (Lamentations and Psalms-1 Peter, Hebrews and James)



Currently researching and working on Work Books and lessons on

Counsellor
Training

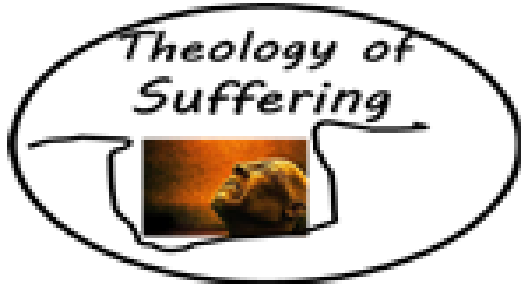

Developing a Philosophy of Pain and Suffering
(Genesis 1-3, Romans, 1 Peter, Hebrews, James)

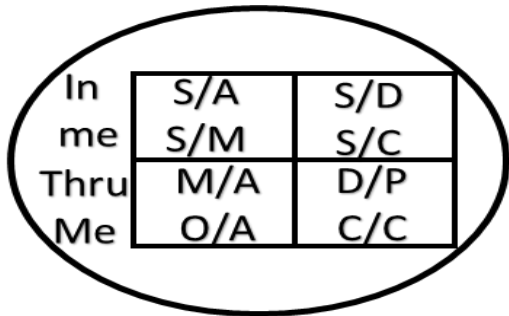

Navigating Emotional Regulation-Maturity (Lamentations
and Psalms-1 Peter, Hebrews and James)

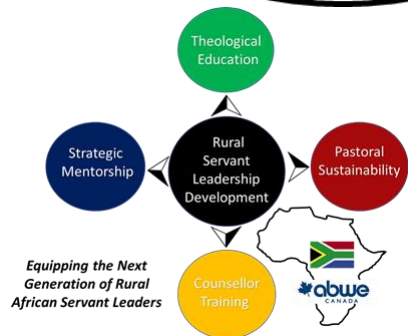

Currently researching and working on Work Books and lessons on

Counsellor
Training



Developing Core Values and understanding the reality of Sabotaging Strategies (Matthew 5:3-16, Romans 7:7-24, Colossians 3:1-17)



Going Through an Understanding of A.D.D.I.C.T.I.O.N. Through a Truth-Based Task - R.E.C.O.V.E.R.Y. (Isaiah 44:9-20, Genesis 1-3)



Currently researching and working on Work Books and lessons on

Counsellor
Training



Covenantal “Into-me-see” – Developing a Biblical understanding of marriage and intimate relationships. (Song of Songs, Proverbs, Genesis 1-3, 1 Corinthians 7, Colossian 3, Ephesians 5)





Pastor Shadrack Khumalo



God is using this godly Pastor for His Glory. Pastor Shadrack is the

- Pastor Benevolence Facilitator
- Pastor of Empangeni Baptist Church
- He mentors the Rural Pastors and Student of Mukhanyo Theological College and Zululand School of then Bible
- We are in constant communication and correspondence



Pastor Eric Ntuli



Developing an Evangelism and Discipleship booklet specifically geared towards Rural Youth and Orphans

Pastor Eric is also a lecturer at Mukhanyo Theological College





Pastor Andile Buthelezi

Pastor of Mtubatuba Baptist Church.
A Biblical sound Pastor who wishes to preach the truth of God's Word. Working together through a biblical response to the challenges in ministry.



Strategic
Mentorship



Mpume:
Manager of Izulu Orphan Project
Desires to learn counselling Skills

Mpume is not just working as a manager of IOP she is deeply involved with girls age 11 upwards. She has recently started a program called "Sister to Sister" that plants the seed of the Gospel in the lives of these girls by working through relevant challenges that young girls face in their rural community. Girls in the rural community can be vulnerable to abuse and intimidation. We are going to work on Biblical and practical principles so that they develop discernment and wisdom throughout their lives.



Strategic Mentorship



Pastor Steve Maka- Originally from Congo as a refugee he wants to be able to discern the Bible and how to teach. He has desire to understand Leadership, and how to work with failure.

He wants develop wisdom, insight and understanding. He wants to work through a list of requirements for a Pastor and practical application of the Bible and Pastoral life

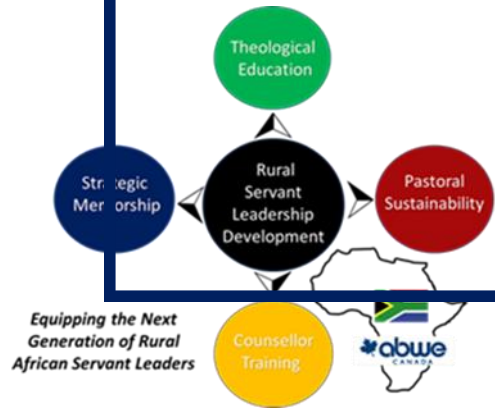



Strategic
Mentorship

Pastor Sibusiso Mpungose

Pastor Sibusiso is pastor of Mountain of God Church.

We are working message preparation and how to do Evangelism and Discipleship. He is also learning theology. He will be attending Mukhanyo Theological College.



Dr. Craig is researching and writing a number of Workbooks for Rural Pastors

Strategic
Mentorship

- Why does knowing and walking with God matter?
- The 12 G's of the Gospel
 - A Biblical View of Shame based on Genesis 3
 - How to work through Conflict Biblically
 - The Fruit of the Spirit as it relates to marriage

